

# Led Flood Light

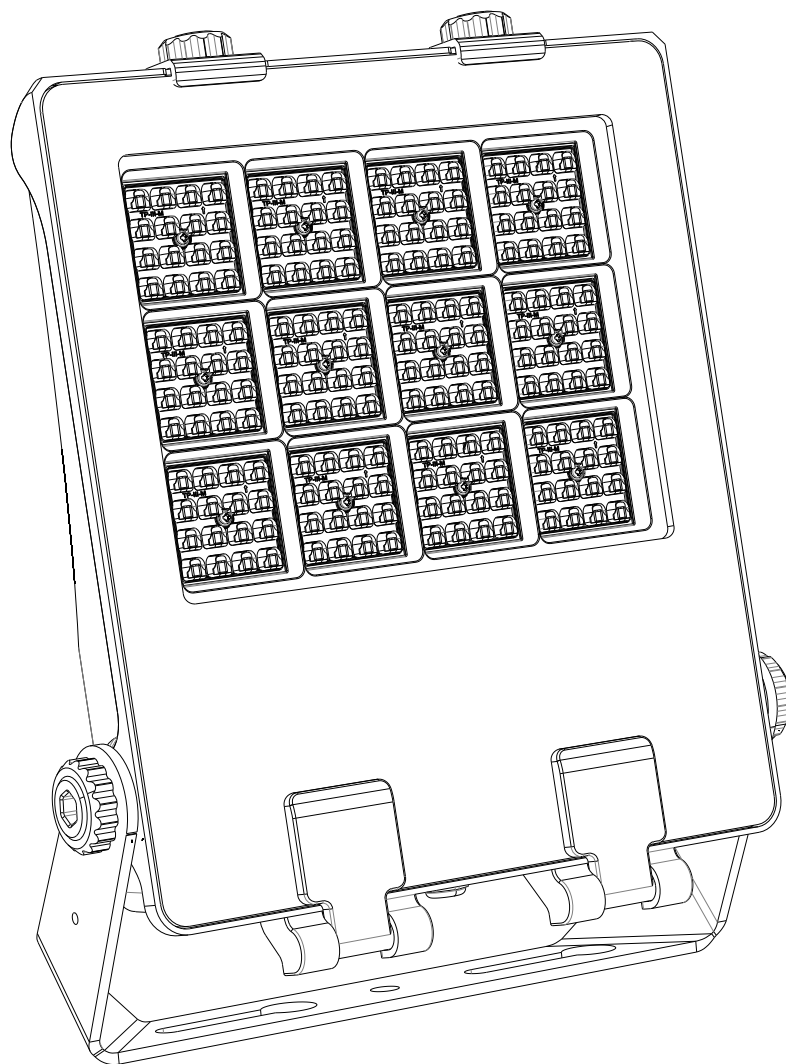

USER MANUAL / MANUAL DE USUARIO  
MANUEL DE L'UTILISATEUR / BEDIENUNGSANLEITUNG  
MANUALE UTENTE / MANUAL DE USUÁRIO



## **WARNING**

Before carrying out any manipulation, make sure to disconnect the luminaire from the power supply. Any incidents in the installation haven't made in accordance with this installation guide will be the responsibility of the installer. Replacement or maintenance of any component must be supplied or recommended by the manufacturer. The light source of this luminaire should be replaced only by the manufacturer, its service or equivalent qualified person.

## **ADVERTENCIA**

Antes de proceder a cualquier manipulación, debe asegurarse de desconectar la luminaria de la alimentación eléctrica. Cualquier incidencia en la instalación que no se haya realizado de acuerdo con esta guía de instalación será responsabilidad del instalador. La fuente de luz de esta luminaria debe reemplazarse únicamente por el fabricante, su servicio técnico o persona cualificada equivalente. La reposición o mantenimiento de cualquier componente deberá ser suministrado o recomendado por el propio fabricante.

## **ATTENTION**

Avant de manipuler, assurez-vous de débrancher l'appareil de l'alimentation électrique. Toute manipulation sur l'installation qui n'a pas été réalisée selon ce guide d'installation est la responsabilité de l'installateur. Le remplacement de tous les composants doivent être fournis ou recommandés par le fabricant. La source lumineuse de ce luminaire ne doit être remplacée que par le fabricant, son service ou sa personne qualifiée équivalente.

## **WARNUNG**

Vor jeder Manipulation, stellen Sie sicher, dass die Leuchte von der Stromversorgung zu trennen. Alle Auswirkungen auf die Installation, die nicht wurde gemäß dieser Installationsanleitung durchgeführt ist die Verantwortung des Installateurs. Der Austausch oder die Wartung von Komponenten muß vom Hersteller geliefert oder empfohlen werden. Die Lichtquelle dieser Leuchte sollte nur durch den Hersteller, seinen Service oder eine gleichwertige qualifizierte Person ersetzt werden.

## **ATTENZIONE**

Prima di qualsiasi manipolazione, assicurarsi di scollegare l'apparecchio dalla rete elettrica. Ogni impatto sulla installazione che non è stata eseguita in base a questa guida di installazione è la responsabilità dell'installatore. Sostituzione o manutenzione di qualsiasi componente devono essere forniti o raccomandati dal fabbricante. La sorgente luminosa di questo apparecchio deve essere sostituita solo dal costruttore, dal suo servizio o da personale qualificato equivalente.

## **AVISO**

Antes de qualquer manipulação, certifique-se de desligar a luminária da fonte de alimentação. Qualquer impacto sobre a instalação que não foi realizada de acordo com este manual de instalação é de responsabilidade do instalador. Substituição ou manutenção de qualquer componente deve ser fornecido ou recomendado pelo fabricante. A fonte luminosa desta luminária deve ser substituída apenas pelo fabricante, pelo seu serviço ou por uma pessoa qualificada.

# Led Flood Light

## WARNING

Connection block included. Installation of the luminaire may require the intervention of a qualified person.



## PHOTOBIOLOGICAL RISK

The luminaire shall be so placed that a prolonged look at the luminaire don't expected at a distance closer to 3 meters

- The floodlight is designed for outdoor applications in industrial areas, sports courts, facade lighting, etc.
- The floodlight settings are designed to operate at a maximum set ambient temperature of  $t_a$  35°C.
- The floodlight has an adjustable support with a radius of 270° to adapt to the position that best suits the needs of the user.
- The floodlight contains last technology protection screens for greater heat dissipation and greater work performance.

## INSTALLATION

### 1. UNPACKAGING

Unpack the luminaire and check that no part hasn't been damaged. If it finds any damage, keep the luminaire back in the packaging and contact us.

### 2. HANDLING

If the luminaire is handled incorrectly after removal from the packaging, damage may occur. Don't knock or stack luminaires after removing them from the packaging.

### 3. INSTALLATION

- Make holes on the surface were be installed to fit the projector bracket to place the screw pins.

## SPECIFICATIONS

**Electrical Power (W):** From 100W to 300W

**Voltage (V):** 100~277V / 220~240V

**Power Factor:** 0,95

**IP protection:** 66

**IK protection:** 08

**Electrical power class:** Class 1

**Fixation:** Screwed on surface. Possibility of fixing on pole up to  $\varnothing$ 64mm with an adjustable support adaptable.

**N.W / G.W: Dimensions (AxB):**

**100W:** 5.1Kg / 6.1Kg & 461\*320\*69mm

**150W:** 5.1Kg / 6.1Kg & 461\*320\*69mm

**200W:** 5.8Kg / 6.8Kg & 461\*380\*69mm

**240W:** 8.6Kg / 10.0Kg & 534\*440\*69mm

**300W:** 9.5Kg / 11.0Kg & 534\*440\*69mm

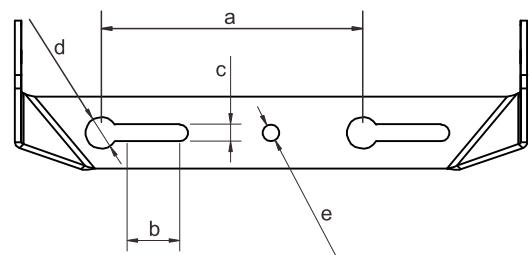
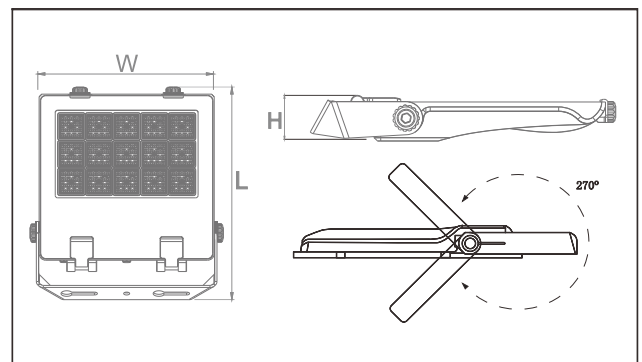

	a	b	c	d	e
100W/150W	160	40	13	25	13
180W/200W	200	40	13	25	13
240W/300W	200	40	13	25	13

Dimension of the bracket

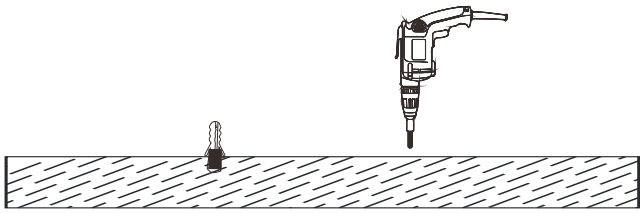

- Once holes have been made, attach the floodlight bracket to the surface as shown in the following image.

**⚠ WARNING**

Under no circumstances hang the luminaire directly from the power cable.

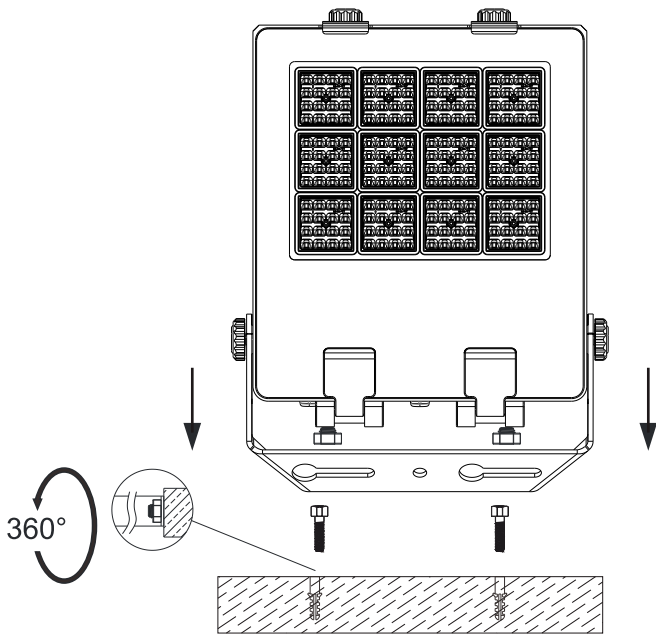

- With the support fixed to the surface and proven to be correctly held, place it in the direction that best fits your needs and proceed to the cable connection.

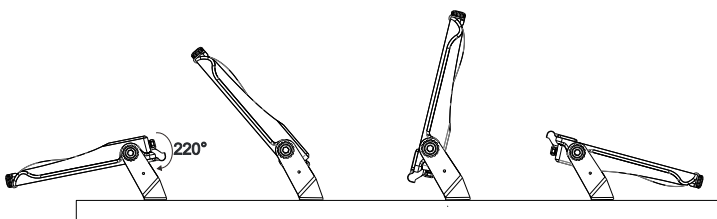

#### 4. WIRING

- Check that the supply voltage is the same as that of the luminaire and are compatible.
- Connect the luminaire to the supply voltage by connecting the cables with their respective colors as shown in the following indications.

**⚠ WARNING**

The flexible cable or outside cord of this luminaire can't be replaced. If the cable is damage, the luminaire must be destroyed.

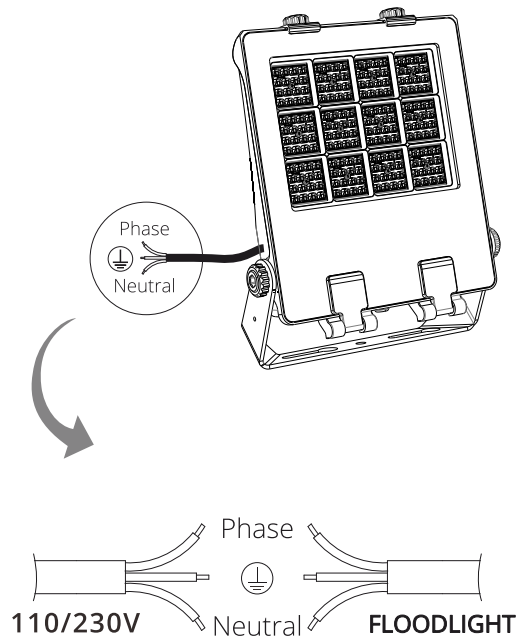

#### Connections

Cable colour:	Supply type:
Brown	Phase
Yellow&Green	Ground ⊕
Blue	Neutral

- Once the connection is made, check that it is working correctly.

#### 5. MAINTENANCE / CLEANING

To improve the efficiency of the floodlight, an occasional cleaning should be done. Disconnect the luminaire from the electric current and wipe the surface with a cloth soaked in water with neutral pH soap.